



WideView

# DS-1500 Series

## Digital Oscilloscope



Supplied by :

Tel: 0027 (011) 683 4365

**Test and Measurement Instruments C.C.**

[www.instrumentsgroup.co.za](http://www.instrumentsgroup.co.za)

## Innovative Design



- ◇ Breathtaking Display Quality - World 1<sup>st</sup> 7" TFT Wide LCD.
- ◇ Soft key-touch, made of silicon materials.
- ◇ Utility compartment at rear side, especially keeping scope probes & other misc. accessories.
- ◇ Choose your favorite color. We provide fashionable design. A variety of front color can be adopted for custom's needs.

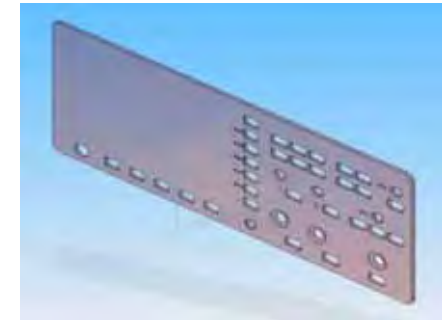
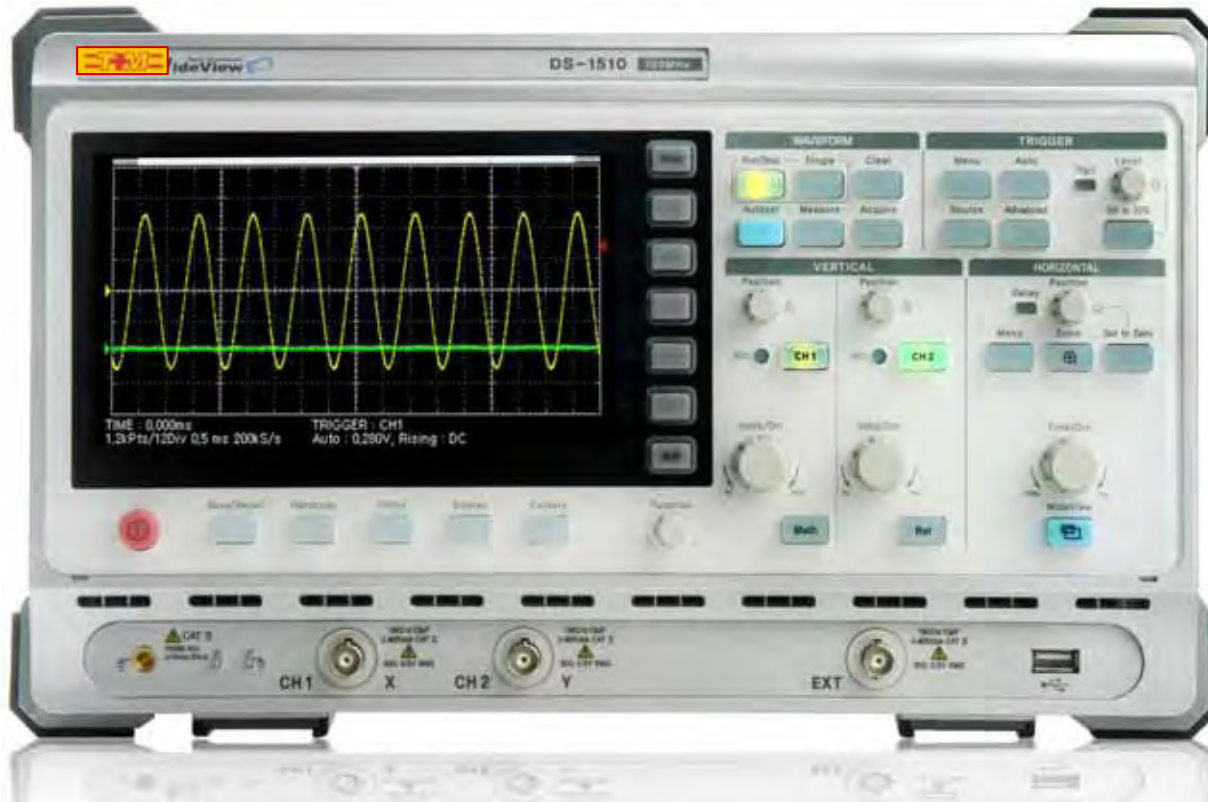

Supplied by :  
Tel: 0027 (011) 683 4365

**Test and Measurement Instruments C.C.**  
[www.instrumentsgroup.co.za](http://www.instrumentsgroup.co.za)

# DSO Comparison Chart



Characteristics	DS1510/1520/1530 -	TDS2012B/2022B TEKTRONIX	DSO3102A/3152A/3202A AGILENT	GDS2102/2202 GOOD WILL
Bandwidth	100/200/300 MHz	100/200 MHz	100/150/200 MHz	100/200 MHz
Sampling Rate	Real Time : 1GS/s Max. Equivalent : 100 GS/s Max.	2012B : 1GS/s each channel 2022B : 2GS/s each channel	Real Time : 1GS/s Max.	Real Time : 1GS/s Max. Equivalent : 25 GS/s Max.
Display	TFT LCD 7" Wide 480×234	Color, 1/4 VGA 320×240	Color, 1/4 VGA 320×240	TFT LCD 5.6" 320×234
Display Graticule	8×12 divisions ; 8×18 divisions (wide on)	8×10 divisions	8×10 divisions	8×10 divisions ; 8×12 divisions (menu off)
OS	Linux	Embedded	Embedded	Embedded
Channels	2	2	2	2
Vertical Resolution	8 bits	8 bits	8 bits	8 bits
Input Impedance	1 MΩ, 50 Ω	1 MΩ	1 MΩ	1 MΩ
Vertical Sensitivity	1 mV ~ 5 V/div	2 mV ~ 5 V/div	2 mV ~ 5 V/div	2 mV ~ 5 V/div
Time Base	Normal : 1ns ~ 1000 s/div (Roll : 50ms ~ 1000 s/div )	2012B : 5 ns ~ 50 s/div 2022B : 2.5 ns ~ 50 s/div (Roll : 100ms ~ 50 s/div )	2 ns ~ 50 s/div	1 ns ~ 10 s/div (Roll : 250 ms ~ 10 s)
Record Length	200kpts per channel	2.5kpts per channel	4kpts per channel	25kpts maximum
Acquisition Rate	Max. 1500 waveforms/s with 32-level variable persistence @ 0.2 us/div	180 waveforms/s, Typical	Not announced	Not announced
I/O Interface	- Standard : RS-232C, USB Host, USB Client - Option : Ethernet IEEE 802.3, USB Host	- Standard : USB Host 2.0 - Option : GPIB	- Standard : USB Host, USB Client - Option : GPIB, RS232w/N2861A	- Standard : RS-232C, USB Host 2.0, - Option : GPIB



Supplied by :  
Tel: 0027 (011) 683 4365

**Test and Measurement Instruments C.C.**  
[www.instrumentsgroup.co.za](http://www.instrumentsgroup.co.za)

# Sampling Rate Comparison 1

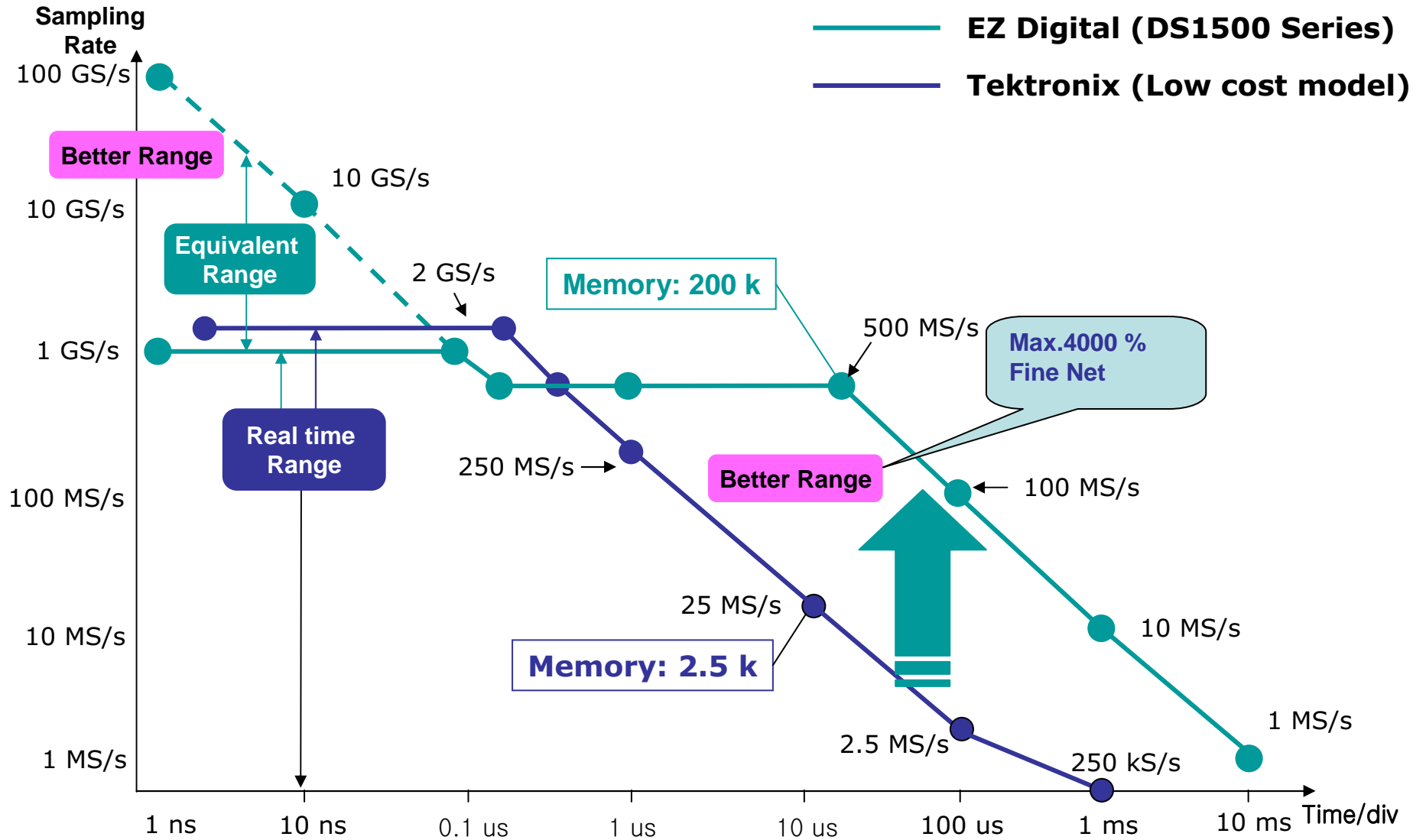

Supplied by :  
Tel: 0027 (011) 683 4365

**Test and Measurement Instruments C.C.**  
[www.instrumentsgroup.co.za](http://www.instrumentsgroup.co.za)

# Sampling Rate Comparison 2

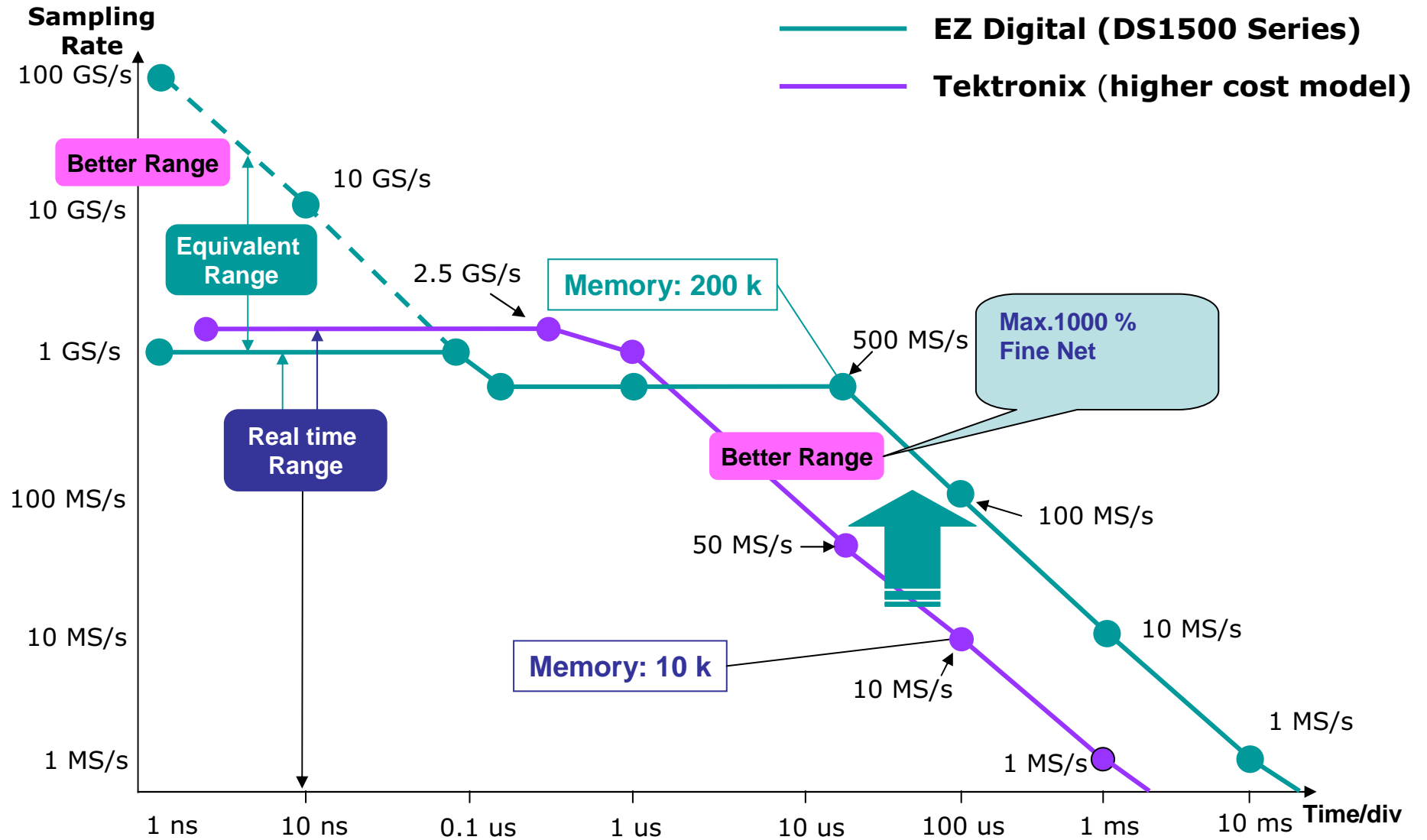



## 1M $\Omega$ , 50 $\Omega$ Impedance Matching

- ◇ 1M $\Omega$  impedance matching: It's used for observing general signals by using oscilloscope probes
- ◇ 50 $\Omega$  impedance matching: It's used for observing RF signals by using Coaxial cable.
  - 1). When observing signals requiring 50 $\Omega$  impedance matching, observation errors frequently occur if impedance matching is ambiguous. Also it's not easy for end-users to contrive another device for impedance matching.
  - 2) Since 50 $\Omega$  impedance matching is built in-side, DS-1500 provide the perfect solution when observing RF signals.

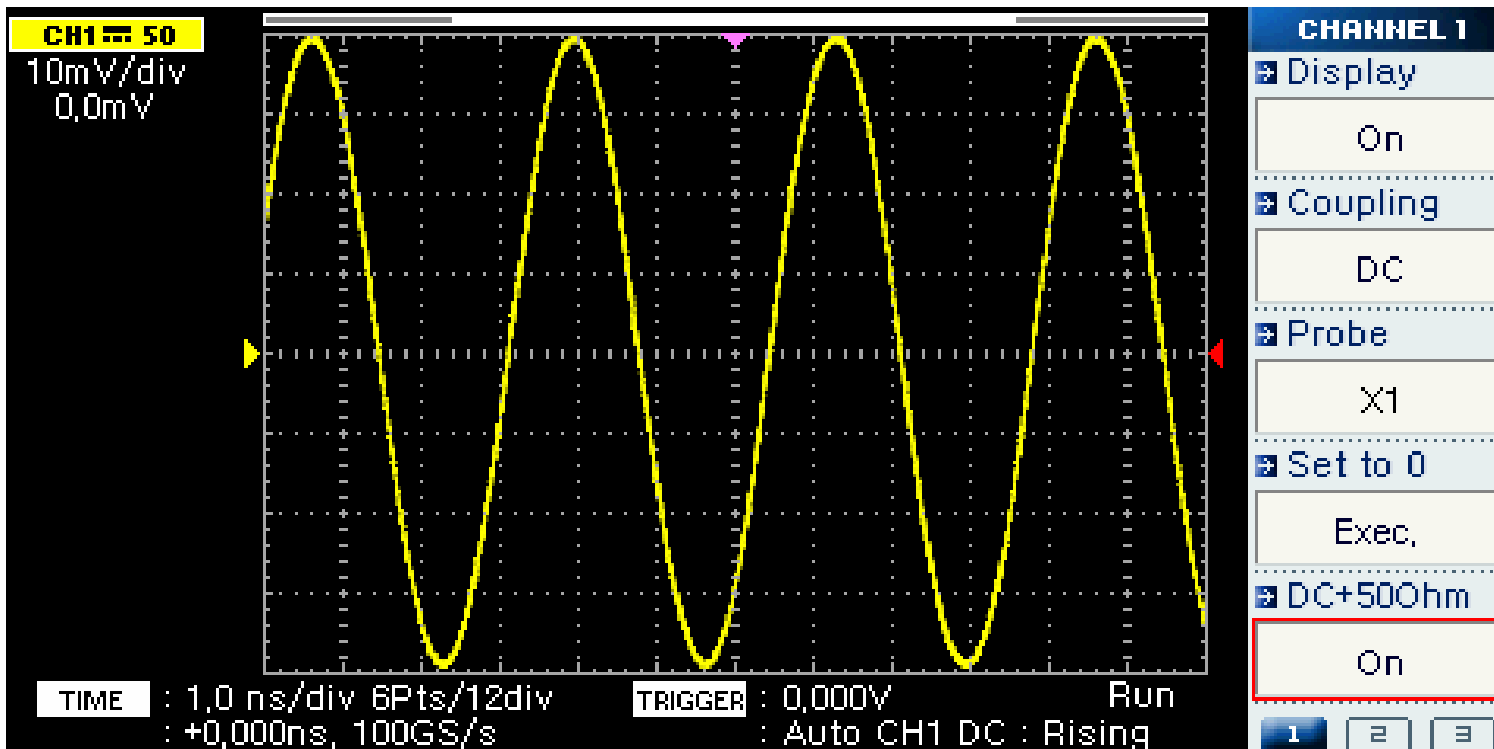

(50 $\Omega$  impedance, 300 MHz Real Picture)



# High Dynamic Range



## Powerful Analog Performance

- ◇ At Maximum Bandwidth, DS-1500 series provides a strong dynamic range along Vertical Axis more than 10 divisions.
- ◇ RF signal is well observed without any distortion and attenuation.

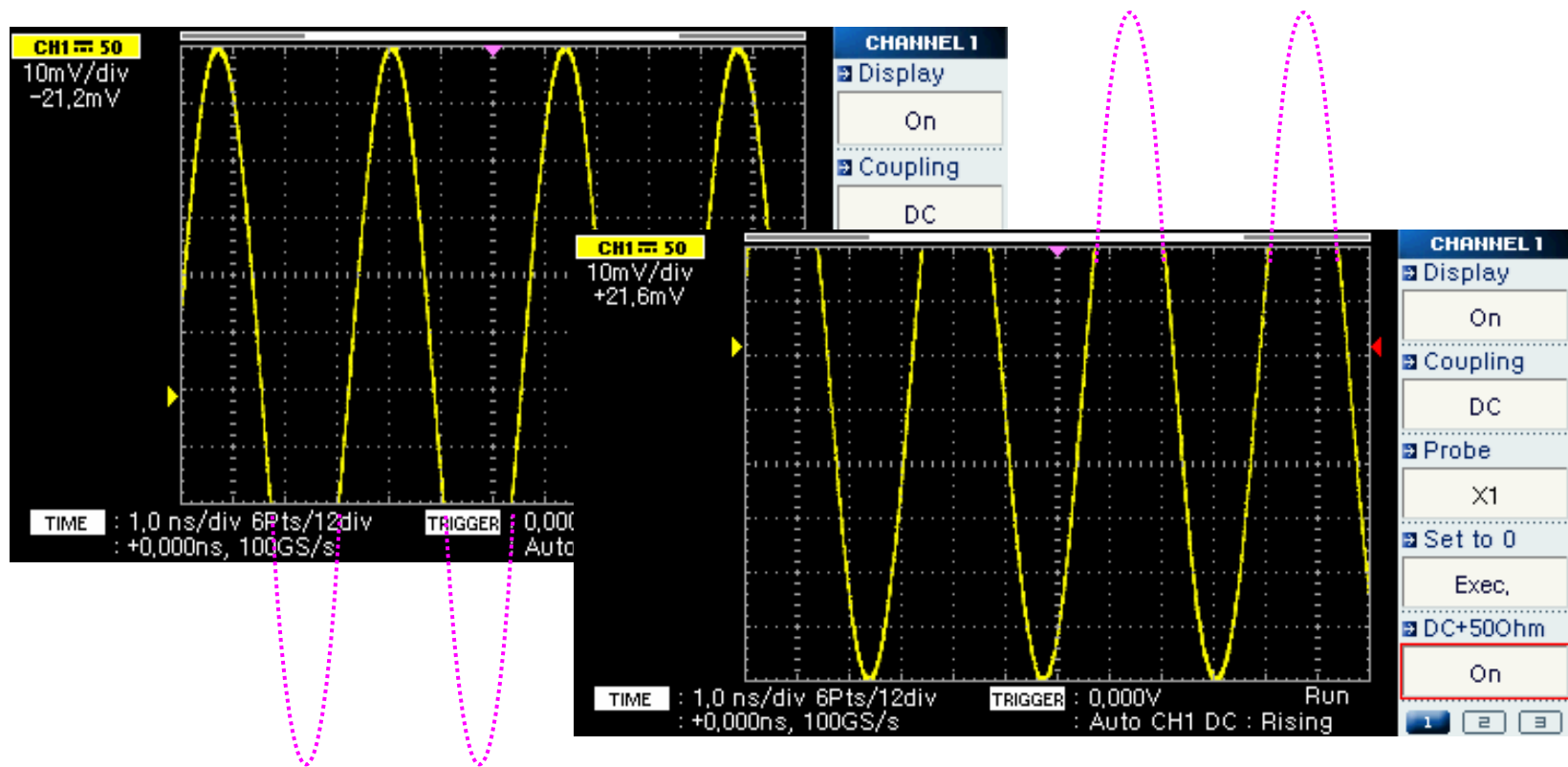

(at 300MHz & 12division, there is no signal distortion)

Explanation: From the marker(▷) reference point, waveform's symmetry between upper and lower sides is accurate



Supplied by :  
Tel: 0027 (011) 683 4365

**Test and Measurement Instruments C.C.**  
[www.instrumentsgroup.co.za](http://www.instrumentsgroup.co.za)

# Single Shot Capture



## Wide single shot capture

◇ Wide LCD enables to capture glitches through Max.  $8 \times 18$  Divisions.

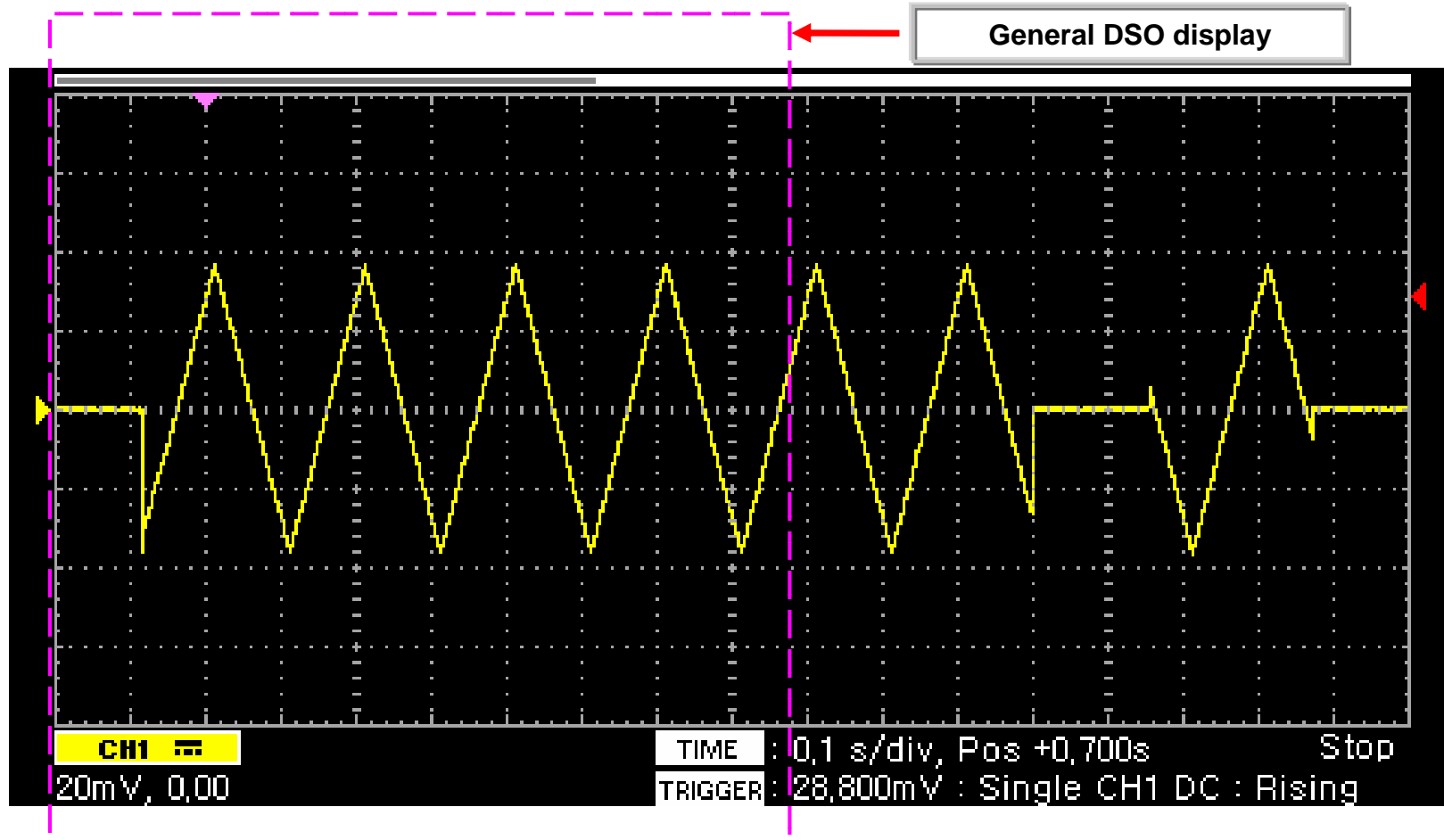

(Ex. Single shot capture in mode of Wide-View display)



Supplied by :

Tel: 0027 (011) 683 4365

**Test and Measurement Instruments C.C.**

[www.instrumentsgroup.co.za](http://www.instrumentsgroup.co.za)





# FFT (Fast Fourier Transform)

◇ Advanced FFT function enables to analyze a Frequency components like Spectrum Analyzer.

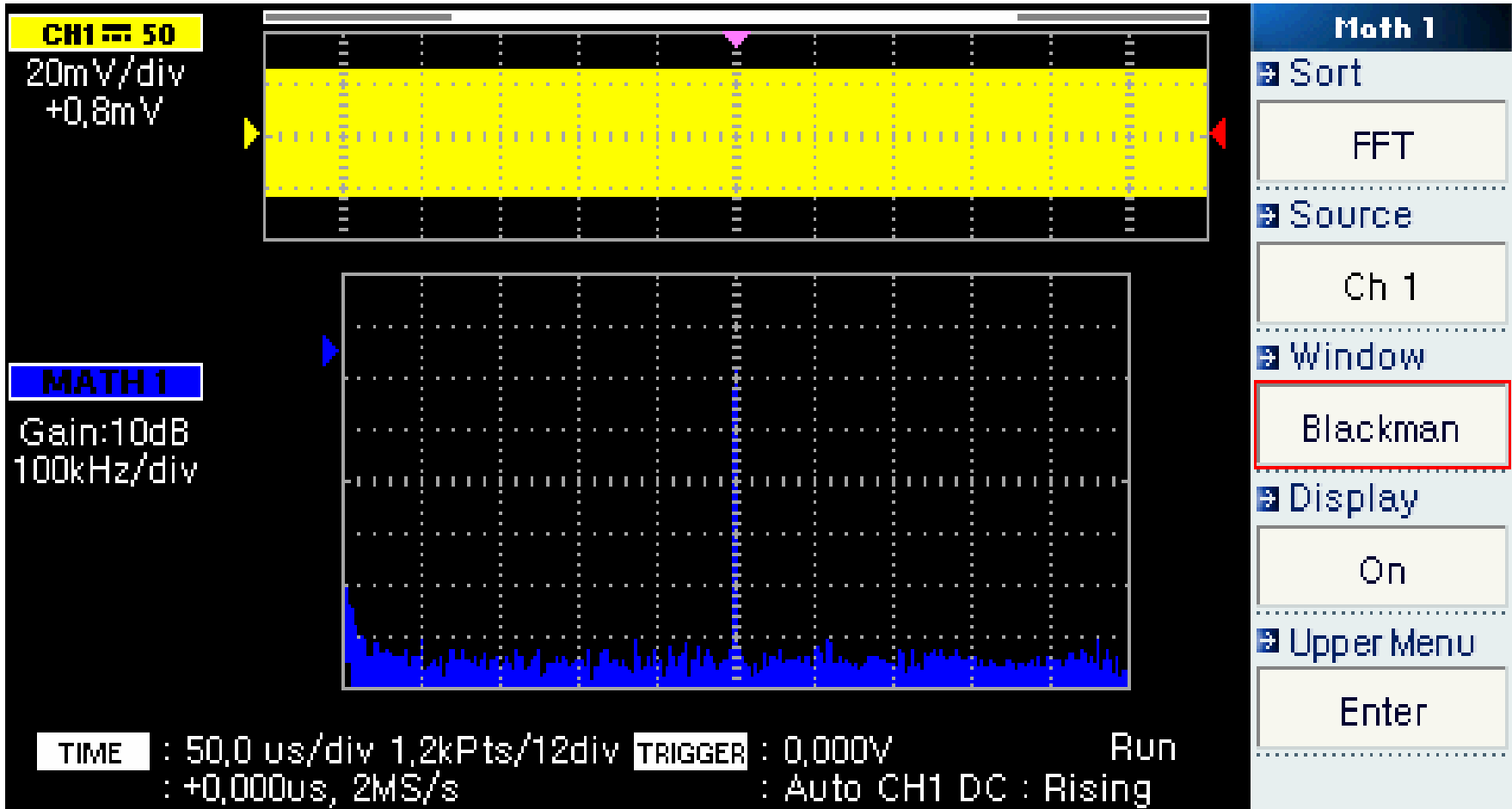

(500kHz sine-wave FFT)



Supplied by :  
Tel: 0027 (011) 683 4365

**Test and Measurement Instruments C.C.**  
[www.instrumentsgroup.co.za](http://www.instrumentsgroup.co.za)



## Alternate Trigger

### Alternating Trigger.

- ◇ Alternating Trigger mode is able to display both signals of which the periods are totally different each other.
  - 1) Alternating trigger mode is capable of generating trigger on each channel source alternately.
  - 2) In mode of general trigger, it's actually difficult to observe both signals of which their periods are different.

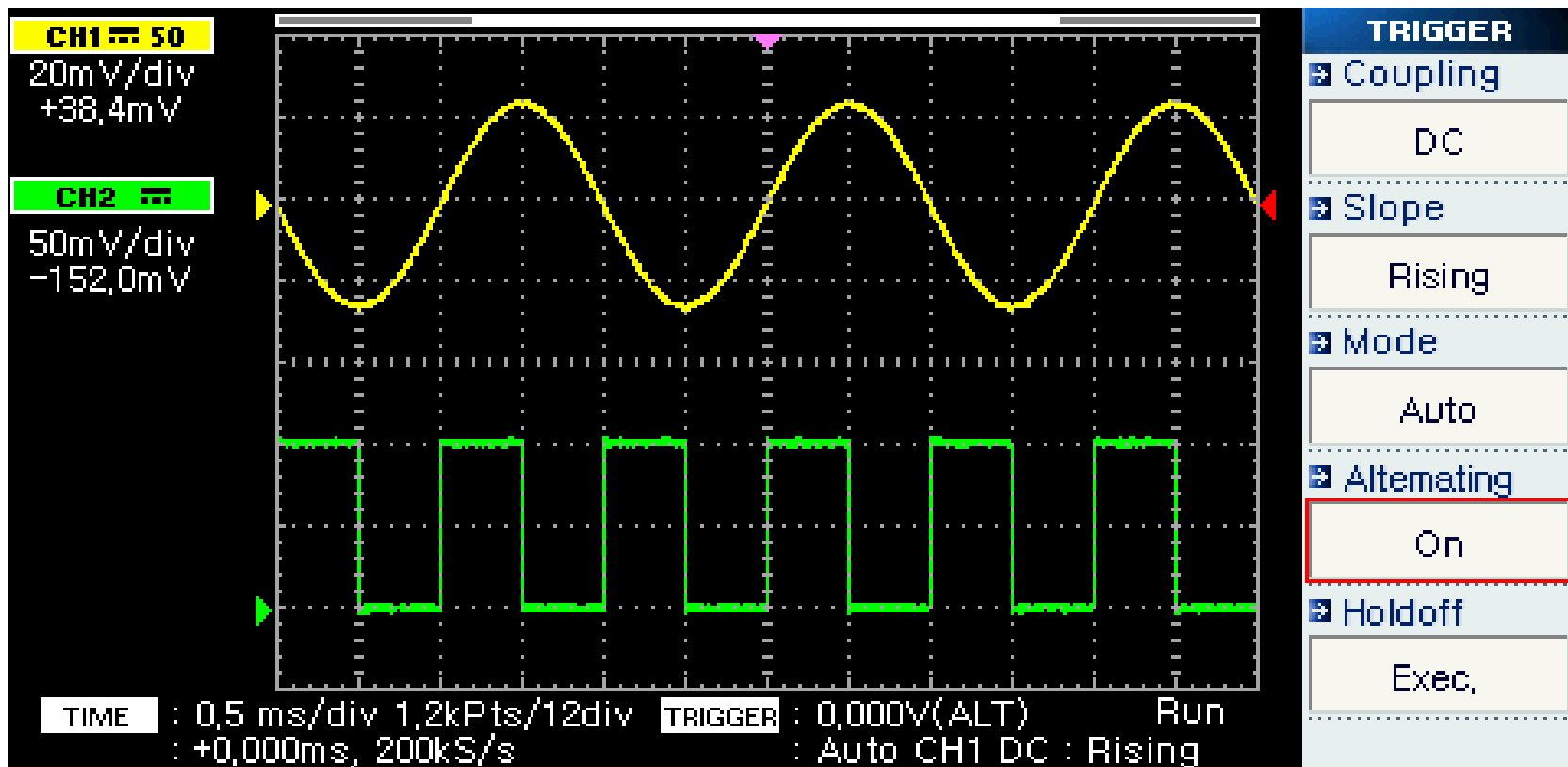

(Ex. Alternate Triggering)





# UART Trigger Capture I

Baud Rate : 115200, Data : 0x31 is captured

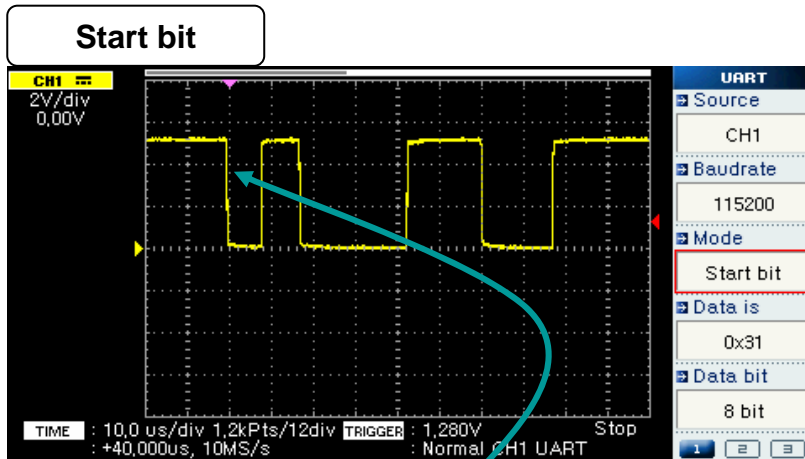

Triggering at Start bit

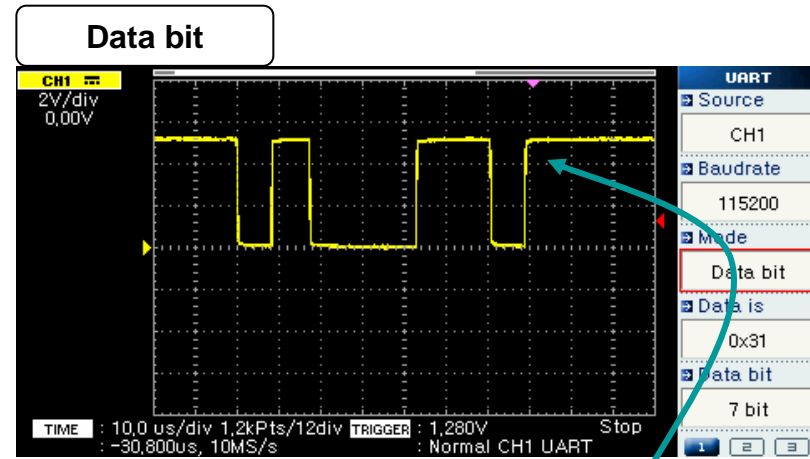

Triggering at Data bit (7 bit)

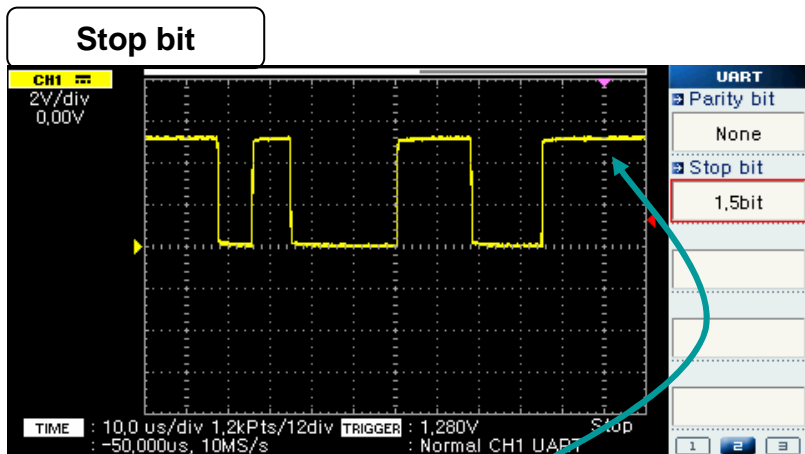

Triggering at Stop bit

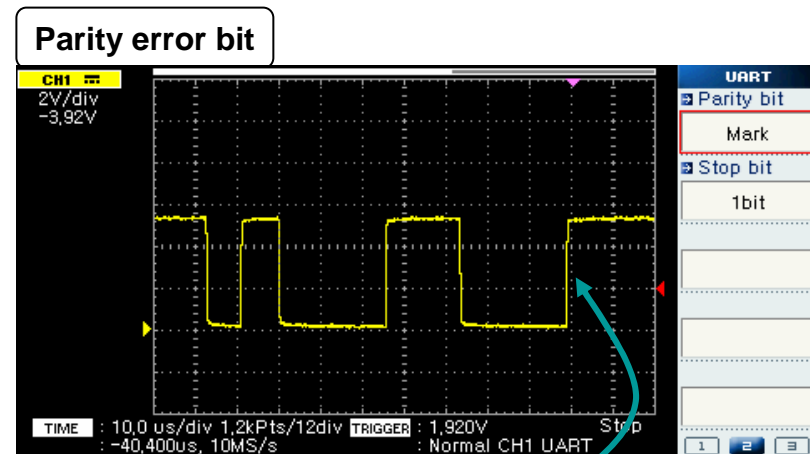

Triggering at Parity error bit



Supplied by :  
Tel: 0027 (011) 683 4365

**Test and Measurement Instruments C.C.**  
[www.instrumentsgroup.co.za](http://www.instrumentsgroup.co.za)

# UART Trigger Capture II

Baud Rate : 115200, Data : 0x31 is captured

- ◇ Condition: Long Memory (200 KB), Zoom window, Wide mode (Time Division: 18 div), ×100 Meg

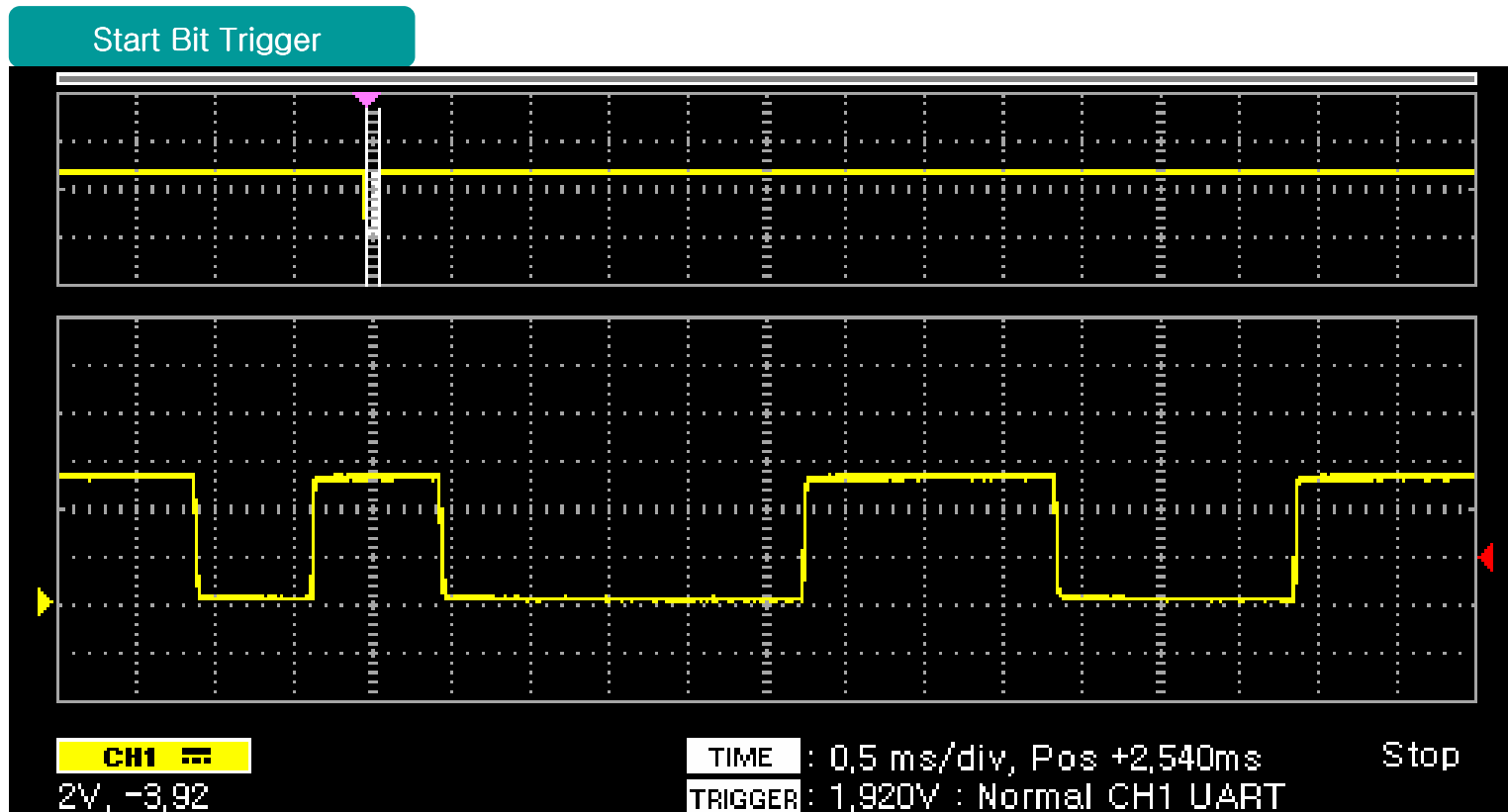



# Waveform Update Rate & Analog-View Technology

- ◇ Powerful waveform update rate: It's much superior to competitor's one more than eight times.
- ◇ Built in **Analog-View Technology**: Among economic oscilloscope models in the world market, only DS-1500 series succeed in adopting Analog-View Technology enabling to display waveforms on LCD as if the waveforms are coming from Cathode-Ray Tube. Analog-View Technology built in DS-1500 series is able to display the persistence of vision of analog CRT on LCD, which show users waveform's cumulative frequency.
- **DS1500 series** : Max. **1,500 waveforms** per second (**32-level Analog-View Technology**)
- **Tek 1000/2000 series**: Max. **180 waveforms** per second (**Analog view persistence is not available**)
- **Tek 3000 series**: Max. **3,000 waveforms** per second, (**Analog view persistence is available**)

## DS1500 Analog-View Technology

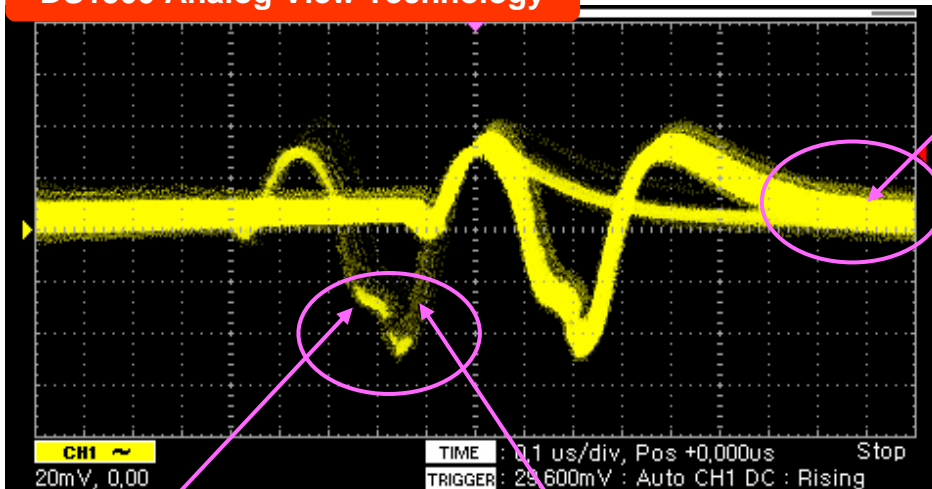

Ex1. Waveform's cumulative frequency is low  
(Display on LCD is dim like CRT)

Ex.2 Waveform's cumulative frequency is high.  
(Display on LCD is bright)

## 18 Time division display

It's capable of observing a hidden part of the waveform

## Tek 3000 Analog-view Persistence

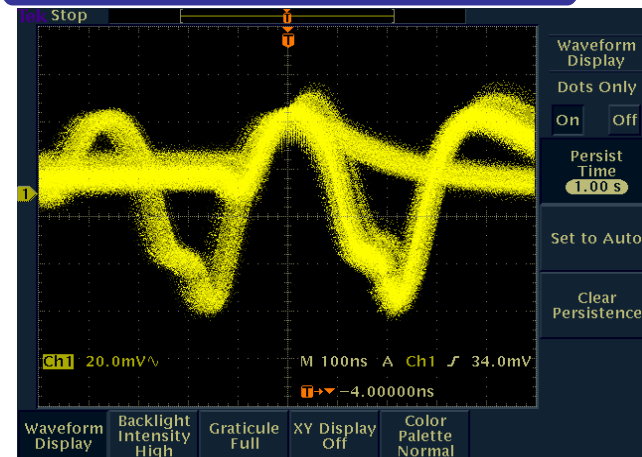

Test condition: Time/dive : 0.1 us, Volts/div : 20 mV



Supplied by :  
Tel: 0027 (011) 683 4365

**Test and Measurement Instruments C.C.**  
[www.instrumentsgroup.co.za](http://www.instrumentsgroup.co.za)

# Wide Display: Find out a hidden waveform



## Wide-View

- ◇ Standard : 8 × 12 divisions, Wide : 8 × 18 divisions.
- ◇ Wide View is absolutely efficient when analyzing signals having complex period.

## Super Zoom

- ◇ Dual window display with × 100 Meg super zoom.

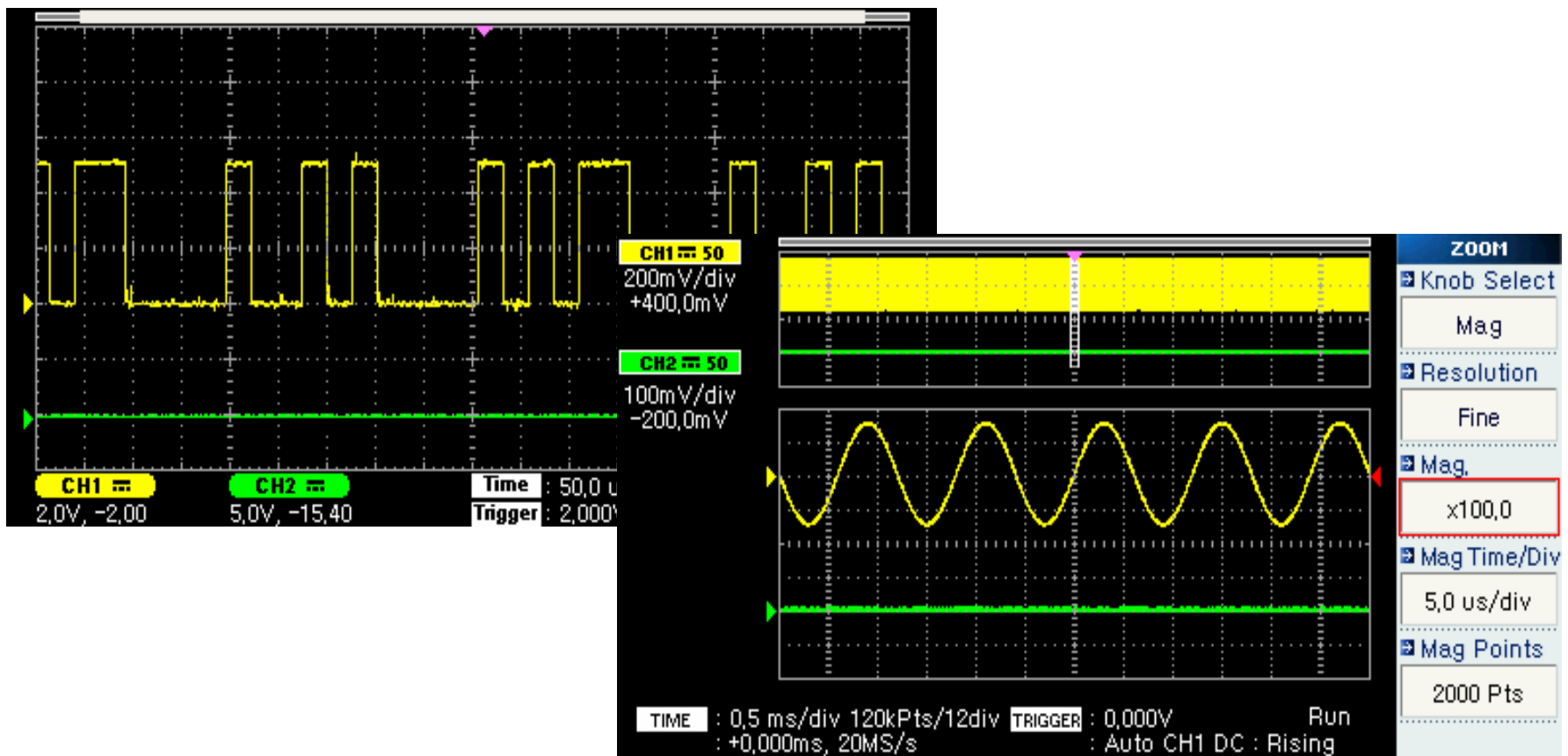

Supplied by :  
Tel: 0027 (011) 683 4365

**Test and Measurement Instruments C.C.**  
[www.instrumentsgroup.co.za](http://www.instrumentsgroup.co.za)

# Self-CAL, DC Auto-Set



## Self-Calibration

With no external signals, Self-Cal can be conducted for temperature compensation.

Oscilloscope is compensated for sudden environment change and it makes durability much longer.

The screenshot shows a software interface for calibration. The main display area is light blue and contains a white rounded rectangle with the text: "Disconnect all probes and cables from Ch1, Ch2 and EXT TRIG". Below this, it shows "Progress : 100 %(Interpolator)" with a full blue progress bar. At the bottom left, it says "Event Code :". On the right side, there is a vertical menu titled "CALIBRATION" with two expandable options: "Interpolator" and "Self". Each option has a corresponding "Enter" button. Below these are two empty input fields and an "Exit" button at the bottom.



Supplied by :

Tel: 0027 (011) 683 4365

**Test and Measurement Instruments C.C.**

[www.instrumentsgroup.co.za](http://www.instrumentsgroup.co.za)

## Ethernet Networking

- ◇ WideView DS-1500 DSOs are able to interchange their waveforms with a Server as long as they are located in the same network area. Up to 30 units are able to have access to the same network and transfer waveforms.
- ◇ This application is very useful for education sector especially, in the training room equipped with Ethernet network. Users don't need to save waveforms into USB memory and don't need to keep their waveforms. Once users save waveforms via Ethernet, user's folder in the server is created and the waveform is saved to the user's folder.

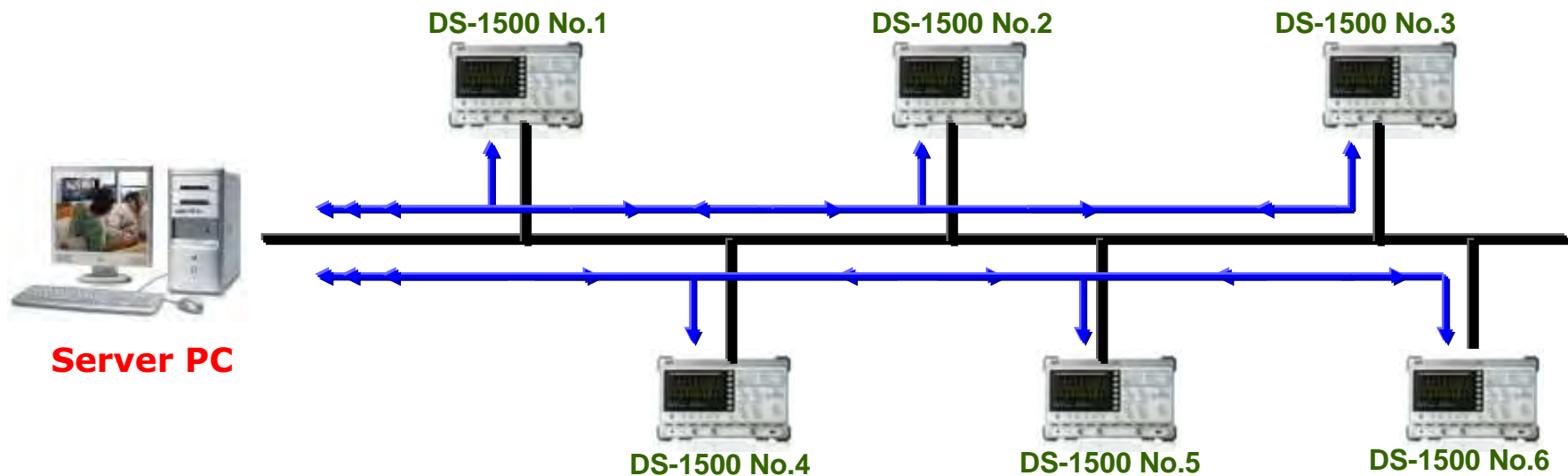



# Soft-View 2.0



## Features

- ◇ Full Screen: Basically display 20Time/Div, which is taking advance of Wide LCD feature
- ◇ Multi connection & Control: Up to 30sets of DS-1500 series can be controlled at remote site
- ◇ Data transfer via Ethernet Network

The screenshot displays the 'Scope View' software interface. It features several windows:

- DSO Tap Window:** Located at the top left, it lists active DSOs with their names and IP addresses. A red dashed box highlights this window.
- DSO Searching Window:** Located at the bottom left, it contains a list of DSOs with their names and IP addresses. A red dashed box highlights this window.
- Display Window:** The central area contains two oscilloscope waveforms. The top window shows a sine wave with settings: CH1: 10mV/div, CH2: 2V/div, TIME: 20ns/div, TRIGGER: 0.56V. The bottom window shows a higher frequency sine wave with settings: CH1: 2V/div, CH2: 5V/div, TIME: 50ns/div, TRIGGER: 0.56V.
- Control Window:** Located on the right side, it contains various control parameters for the DSOs, including CH1, CH2, REF1, REF2, Display, Coupling, DC=500ms, Probe, B/W Limit, Set to 0, Volt/Div, Volt/Pos, TIME (Horizontal), TRIGGER (Mode, Source, Couple, Slope, Level, Set to 50%), and WAVEFORM (Run / Stop, Single, Autoset).

Arrows point from the labels to the corresponding windows in the screenshot.



Supplied by :  
Tel: 0027 (011) 683 4365

**Test and Measurement Instruments C.C.**  
[www.instrumentsgroup.co.za](http://www.instrumentsgroup.co.za)